

SPRING 12 ISSUE 42

WIRINGMATTERS

The Institution of Engineering and Technology

ELECTRICAL REQUIREMENTS FOR SWIMMING POOLS



Special Locations
Requirements for
installations at
Filling Stations

17th Edition
Amendment No 1 and
installations designed
from January 2012

PAT tests
Challenging the
myths of portable
appliance testing

Sections 570 & 557
Co-ordination of
electrical devices and
auxiliary circuits



Almost 8.00?
It's not too late

Flippin' great!

Buy online any time

At Neweys Online you can order all electrical supplies at your agreed prices, 24 hours a day!

- Get next day delivery if ordered by 8pm, or
- Collect from your local branch

The same team, the same service just a whole lot more convenient.



 **neweysonline.co.uk**

QUICK: CLICK: **JOB DONE!**

Co-ordination of electrical devices and auxiliary circuits



Two new areas of possible development within European and International standards are Section 570 requirements for the co-ordination of electrical devices and Section 557 requirements for auxiliary circuits.

By Geoff Cronshaw

SECTION 570 - INTRODUCTION

Section 570, which is still at a very early stage of development in CENELEC, gives the rules for the selection and erection of electrical devices within an electrical installation with respect to coordination. The draft standard provides requirements for the selection of electrical devices to ensure electrical coordination between them in case of a fault including overcurrent protective devices such as

fuses and circuit breakers and residual current devices.

This is a completely new section. The current requirements for coordination in BS 7671 are given in a small number of regulations contained in section 536. Regulation 536.1 sets out the requirements for coordination and requires discrimination to be considered to prevent danger and where required for proper functioning of the installation. Chapter 36 of BS 7671 uses life support systems as an example where

continuity of service is required.

Co-ordination

Regulation 536.1 states that where co-ordination of series protective devices is necessary to prevent danger and where required for proper functioning of the installation, consideration shall be given to selectivity and/or any necessary back-up protection

The term “Co-ordination” generally relates to two subjects:

- Selectivity (also known as discrimination)
- Back-up protection (also known as cascading).

Some fundamentals of each subject are briefly covered below however; it must be appreciated that more complex engineering principles will apply and that the manufacturer's data and instructions should be taken into account.

Selectivity

Selectivity is the ability of a protective device to operate in preference to another protective device in series. (see figure 1.)

Regulation 536.2 states that: “Where selectivity between overcurrent protective devices is necessary to prevent danger and where required for proper functioning of the installation, the manufacturer’s instructions shall be taken into account”.

Selectivity can be by current or time. Time discrimination utilises in-built time delays in the upstream devices, though current discrimination is the more common method used. This form can be divided into either overload discrimination or fault current discrimination. Time/current characteristic graphs for the protective devices can be overlaid to check for overload discrimination.

Back-up protection

Regulation 536.4 states: “Where necessary to prevent danger and where required for proper functioning of the installation, back-up protection shall be provided according to the manufacturer’s information”. Also, Regulation 536.5.1

states: “A switching device without integral overcurrent protection shall be co-ordinated with an appropriate overcurrent protective device.

The principle of back-up protection is embodied in Regulation 434.5.1 e.g. the characteristics of the devices shall be co-ordinated so that the energy let-through of these devices does not exceed that which can be withstood, without damage, by the lower breaking capacity device(s)

It is very important to note that technical data for the selection of protective devices for the purpose of back-up protection is published by the manufacturer and should be followed.

OVERCURRENT PROTECTIVE DEVICES

Every circuit must be provided with a means of overload and fault current protection although some circuits may be protected against overload by the nature of the load (exceptions are permitted where unexpected disconnection could cause danger, and the designer should consult Sections 433 and 434 of BS 7671 for details). The devices may either be fuses or circuit breakers. The choice of device will depend on a number of factors, including overall installation and maintenance costs. When designing a distribution system it is necessary to consider effective discrimination.

Protective devices in an installation should be graded so that when a fault occurs the device nearest to the fault operates and leaves the other devices intact.

Fuses

The key requirement for there to be discrimination between fuses is that the total I^2t of the minor fuse must not exceed the pre-arcing I^2t of the major fuse. Pre-arcing I^2t is the energy required to take the fuse element to the point where it starts to melt. Total operating I^2t is the total energy until the arc is quenched. This information is available from the manufacturer. For discrimination between two circuit breakers the fault current should be less than ►

Figure 1

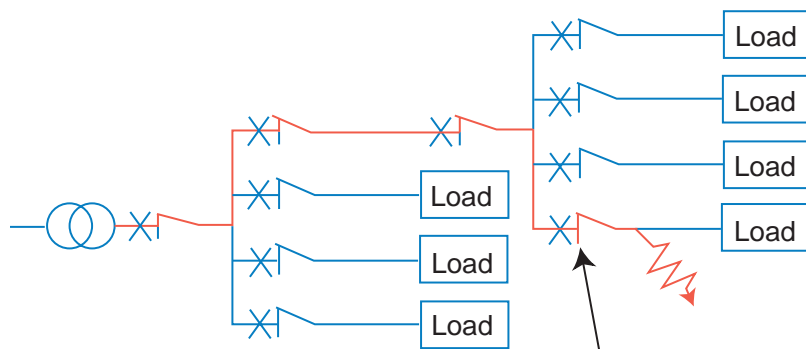

Discrimination achieved if only this device operates



Wiring Matters is a quarterly publication produced by IET Services Limited, a subsidiary of The Institution of Engineering and Technology (IET), for the IET. Michael Faraday House, Six Hills Way, Stevenage, Herts, SG1 2AY, United Kingdom Tel: +44 (0)1438 313311 Fax: +44 (0)1438 313465. The Institution of Engineering and Technology is registered as a Charity in England & Wales (no 211014) and Scotland (no SC038698). The IET is not as a body responsible for the opinions expressed.

Advertising Sales D Thomasson +44 (0)1438 767224 dthomasson@theiet.org | **Editor** G D Cronshaw +44 (0)1438 767384 gcronshaw@theiet.org |

Contributing Editors M Coles, R Townsend, P Bicheno | **Sub editors** Jim Hannah, Leanne Farnell | **Design** John Rooney, Jon Bonny, Dan Shadrake |

Production controller Nikki McEllin

©2012: The Institution of Engineering and Technology. All rights reserved. No part of this publication may be reproduced, stored in a retrieval system, or transmitted in any form or by any means without the permission in writing of the publisher. Copying of articles is not permitted except for personal and internal use. Multiple copying of the content of this publication without permission is always illegal. Printed by Wyndeham Group.

Cooperating Organisations The Institution of Engineering & Technology acknowledges the contribution made by the following organisations in the preparation of this publication: British Electrotechnical & Allied Manufacturers Association Ltd – P D Galbraith, M H Mullins | Department for Communities and Local Government – I Drummond | Electrical Contractors Association – City & Guilds of London Institute – H R Lovegrove | Electrical Contractors Association of Scotland SELECT – N McGuiness | Health & Safety Executive – K Morton | Electrical Safety Council | ERA Technology Limited – M Coates, A Finney | Consultant - M. Al-Rufaie | Dept of Health - C Holme | British Cables Association – C Reed | Scottish Building Standards Agency | Department for Business, Enterprise and Regulatory Reform | GAMBICA – M Hadley, A. Sedhev | Lighting Association – L Barling
ISSN 1749-978-X



The world's most productive PAT tester

NEW PAT400 series - Automatic appliance tester with on-board asset memory.

- Memory for 10,000 asset tests to keep you on the job longer
- Continuous operation, no stopping while the machine cools down
- Soft keys to speed you through the testing process
- The most productive tester in its class

Want to know more? Call 01304 502 101 now

or visit www.megger.com/uk

Megger

WWW.MEGGER.COM

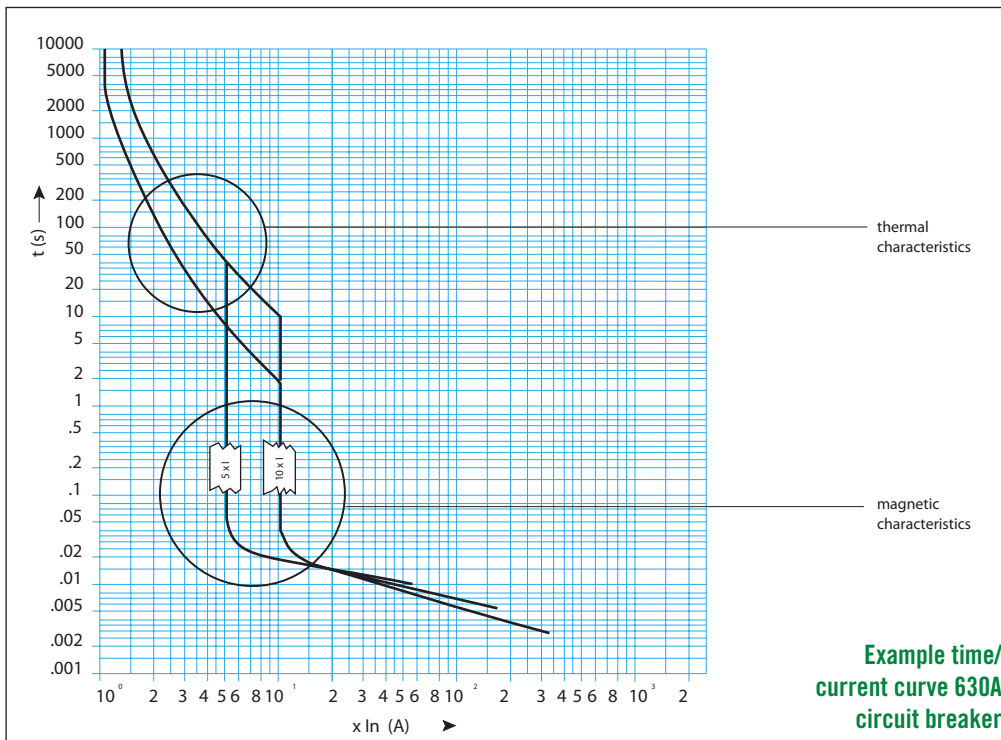

1.45 I_n relates directly to circuit design, in section 433 protection against overload current, regulation 433.1.1 states that:

the operating characteristics of a device protecting a conductor against overload shall satisfy the following conditions:

- (i) the rated current or current setting of the protective device (I_n) is not less than the design current (I_b) of the circuit, and
- (ii) the rated current or current setting of the protective device (I_n) does not exceed the lowest of the current-carrying capacities (I_z) of any of the conductors of the circuit, and
- (iii) the current (I_2) causing effective operation of the protective device does not exceed 1.45 times the lowest current carrying capacities (I_z) of any of the conductors of the circuit.

the instantaneous tripping current of the higher circuit breaker. If the fault current is greater than the instantaneous tripping current of the higher circuit breaker both circuit breakers will trip instantaneously and no discrimination will exist under fault conditions.

Circuit breakers

There are many types of circuit breaker available, the most common being the 'thermal magnetic circuit breaker'. 'Miniature circuit breakers' (MCBs) should comply with BS EN 60898 entitled 'Circuit-breakers for Overcurrent Protection for Household and Similar Installations'. The scope identifies they are designed for use by an uninstructed person. The maximum rated current permitted is 125 A.

'Air Circuit Breakers (ACB)' or 'Moulded Case Circuit Breakers (MCCB)' are for use by instructed persons. These devices should comply with BS EN 60947-2 entitled 'Low Voltage Switchgear and Controlgear – Part 2: Circuit Breakers'. The scope identifies that this standard applies to circuit breakers with a rated voltage not exceeding 1000 V a.c. or 1500 V d.c. and places no restriction on rated current. The minimum size available is 16 A.

The rated current I_n can be defined as the current which a circuit breaker will carry continuously under specified conditions on which the time / current characteristics are based. In BS EN 60 898 this calibration is always carried out at a reference ambient temperature of 30°C

unless otherwise stated. Devices covered by BS EN 60947-2 are calibrated at 40°C. The value of I_n can be fixed by the manufacturer or can be adjusted by the installer. Note: Adjustable releases are not available on BS EN 60898 devices.

Thermal trip

A thermal bi-metallic trip is used to protect against overload currents. The bi-metallic or thermal sensing element deflects mechanically as current passes through it. The higher the overcurrent, the greater the deflection. At a predetermined point the element will actuate a tripping mechanism, open the contacts and disconnect the circuit. This action is represented by the inverse time characteristic (curved section) of the circuit breaker's tripping

Factor of 1.45 ensures that deterioration of cables does not result from small overloads. This is based upon practical studies and experience that has shown when a current of 1.45 times the current carrying capacity of the cable is interrupted within the conventional times, there is no significant deterioration in the working life of the cable.

Magnetic Characteristic

The magnetic characteristics on BS EN 60898 circuit breakers are fixed. Devices with a common nominal current rating are available in three different types. A letter preceding the nominal current rating i.e. B20 for a 20A type B circuit breaker denotes the type of device. The letters B, C, or D relate to the magnetic trip setting or characteristic curve, see ►

Figure 2

Type	Magnetic trip setting	Application
B	3 - 5 I_n	General Domestic Use, resistive loads
C	5 - 10 I_n	Motors, Fluorescent Lighting, inductive loads
D	10 - 20 I_n	Transformers, Sodium Lighting, Highly Inductive Loads

The Standard BS EN 60898 refers to 1.45 I_n as the conventional tripping current which must open the circuit breaker contacts within the conventional time. This is defined as one or two hours.



FIREX South

FIRE PREVENTION, DETECTION & PROTECTION

13-14 March 2012, Sandown Exhibition Centre, UK

THE EASIEST WAY TO IMPROVE YOUR FIRE SAFETY KNOWLEDGE & SOURCE NEW SOLUTIONS.

- FREE ONE-DAY WORKSHOP ON FIRE SAFETY IN HOUSING**
- 100S OF PRODUCTS UNDER ONE ROOF**
- 60+ LEADING EXHIBITORS**
- CONVENIENT LOCATION BENEFITTING FROM FREE PARKING**
- FREE EDUCATIONAL SEMINARS AT THE INFO4FIRE.COM LEARNING ZONE**

→ SEMINAR TOPICS INCLUDE:

INTEGRATING FIRE DETECTION INTO BUILDING MANAGEMENT SYSTEMS; HOW TO AVOID UNWANTED FIRE ALARM SIGNALS; THE APPLICATION OF WIRE-FREE DETECTION AND ALARM SOLUTIONS IN SMALL AND MEDIUM-SIZE BUILDINGS; TESTING AND APPROVING VISUAL ALARM DEVICES TO EN54-23

**REGISTER FOR FREE ENTRY
WWW.INFO4FIRE.COM/FIREXSOUTH
AND ENTER CODE WIRINZ**

Official Media Partner:



Organised by:



'B' curve (BS EN 60 – 898)
MCBs: MT rated 6 – 63A
NB rated 6 – 63A

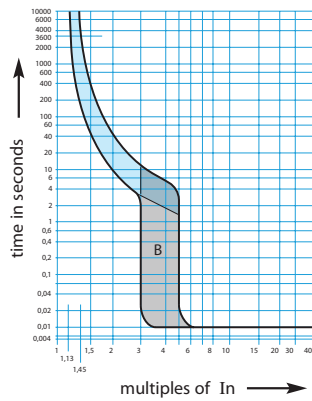

'C' curve (BS EN 60 – 898)
MCBs: NC rated 0.5 – 63A
ML rated 2 – 32A
NM rated 80 – 100A

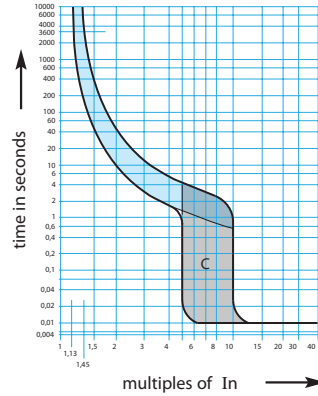

'D' curve (BS EN 60 – 898)
MCBs: ND rated 6 – 63A

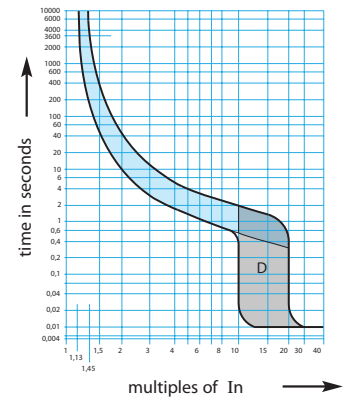

figure 2. This component of the circuit breaker is constructed using a coil or solenoid, which is designed to operate the tripping mechanism when the overcurrent reaches a set magnitude. This magnetic component is specifically designed to deal with fault current.

As can be seen from the above graphs, the letter B, C, or D represents a multiple of I_n . When the current rises to this multiple value, the magnetic trip operates instantaneously to open the contacts.

RESIDUAL CURRENT DEVICES

An RCD is a protective device used to automatically disconnect the electrical supply when an imbalance is detected between live conductors. In the case of a single-phase circuit, the device monitors the difference in currents between the line and neutral conductors. If a line to earth develops, a portion of the line conductor current will not return through the neutral conductor. The device monitors this difference, operates and disconnects the circuit when the residual current reaches a preset limit,

the residual operating current ($I_{\Delta n}$). An RCD on its own does not provide protection against overcurrents. Overcurrent protection is provided by a fuse or a circuit-breaker. However, combined RCD and circuit breakers are available and are designated RCBOs.

Unwanted tripping of RCDs can occur when a protective conductor current or leakage current causes unnecessary operation of the RCD. An RCD must be so selected and the electrical circuits so subdivided that any protective conductor current that may be expected to occur during normal operation of the connected load(s) will be unlikely to cause unnecessary tripping of the device.

Discrimination: Where two or more RCDs are connected in series, discrimination must be provided, if necessary, to prevent danger. During a fault, discrimination will be achieved when the device electrically nearest to the fault operates and does not affect other upstream devices. Discrimination will be achieved when 'S' (Selective) types are used in conjunction with downstream

general type RCDs. The 'S' type has a built-in time delay and provides discrimination by simply ignoring the fault for a set period of time allowing more sensitive downstream devices to operate and remove the

fault. For example, when two RCDs are connected in series, to provide discrimination, the first RCD should be an **'S' type. RCDs with built in time delays should not be used to provide personal protection.**



RCBO – residual current circuit breaker with overcurrent protection

SECTION 557 AUXILIARY CIRCUITS

Section 557 applies to auxiliary circuits for low voltage electrical installations. Auxiliary circuits are defined as circuits for transmission of signals intended for detection, supervision or control of the functional status of a main circuit such as circuits for control, signalling and measurement.

Auxiliary circuits in connection with fire and intruder alarms, traffic lights etc (where specific standards exist) are excluded.

This is a completely new section. The current requirements for auxiliary circuits in BS 7671 are given in regulation 537.5.3 (extract below).

537.5.3 A circuit shall be designed, arranged and protected to limit dangers resulting from a fault between the control circuit and other conductive parts liable to cause malfunction (e.g. inadvertent operation) of the controlled equipment.

The draft standard covers issues such as ac or dc auxiliary circuits, power supplies for auxiliary circuits dependent on the main circuit, also, auxiliary circuits supplied by an independent source, protection against overcurrent, and types and sizes of cables for auxiliary circuits. Also special requirements for auxiliary circuits used for measurement. Functional safety and EMC are also covered.

For example, in the situation where the auxiliary circuit is supplied by an independent source, e.g. by batteries or a power supply independent from the mains, in the event of a loss of supply of the main circuit the independent auxiliary circuit shall not create a hazardous situation. Also, in case of the use of batteries as power supply for auxiliary circuits the voltage fluctuation due to charging or discharging shall not exceed certain voltage tolerances.

In situations where the auxiliary circuit is supplied from the main circuit via a transformer or rectifier requirements for the connection of the devices are covered and also protection against overcurrent. Furthermore, detailed

requirements are included for circuits used for measurement, such as connection requirements for voltage and current transformers etc.

Conclusion

It is important to point out that this article is only intended as a brief overview of issues that are being considered at a very early stage and therefore may not become European and International standards. Persons involved in this area are recommended to seek specialist advice. ■

Acknowledgements

Special thanks to Hager for some of the images and information contained in this article. Also special thanks to Schneider Electric and MK for some of the images used.



Accessibility of connections and maintenance-free junction boxes

The introduction of maintenance free junction boxes was a small change made in the last Amendment but it is likely to have the most practical results.

By Paul Cook

Amendment No 1

One of the smaller changes made by Amendment No 1 was the introduction of maintenance free junction boxes. Item (vi) was added to regulation 526.3:

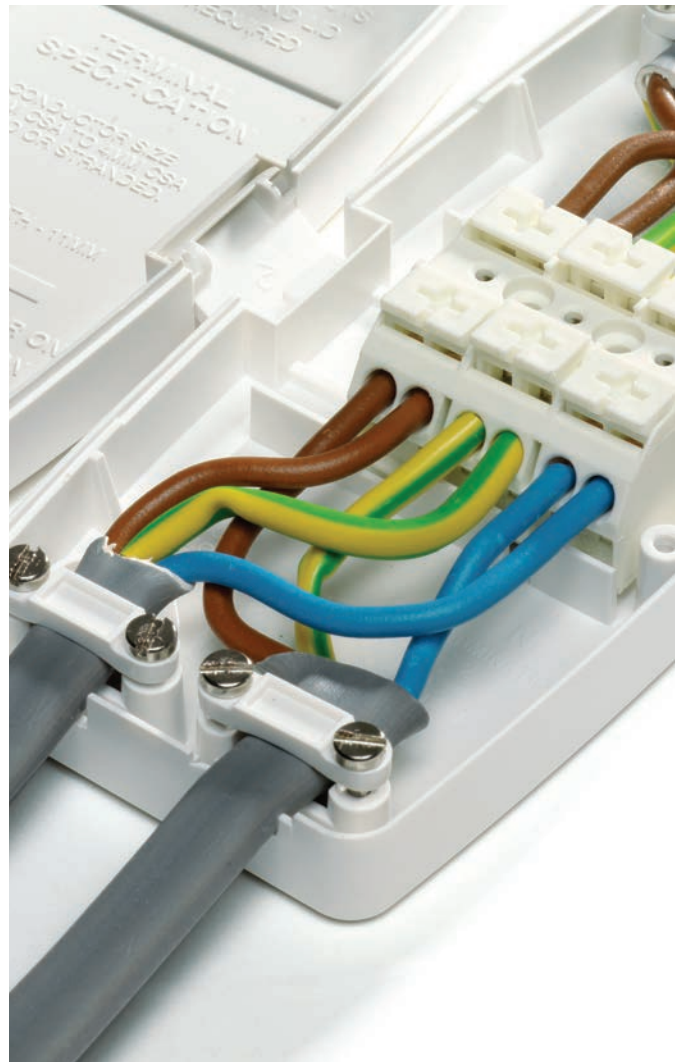

526.3 Every connection shall be accessible for inspection, testing and maintenance except for the following:

- (i) A joint designed to be buried in the ground
- (ii) A compound-filled or encapsulated joint
- (iii) A connection between a cold tail and the heating element as in ceiling heating, floor heating or a trace heating system
- (iv) A joint made by welding, soldering, brazing or appropriate compression tool
- (v) Joints or connections made in equipment by the manufacturer of the product and not intended to be inspected or maintained

(vi) Equipment complying with BS 5733 for maintenance-free accessory and marked with the symbol  and installed in accordance with the manufacturer's instructions.

This amendment allows junction boxes complying with the maintenance free requirements of BS 5733 as well as the general requirements of BS 5733 to be installed in inaccessible positions.

There has always been much debate as to when a junction box is accessible. Is it accessible when installed under floorboards, is a trap necessary, is a screwed down floorboard acceptable? Do fitted carpets make any difference? And the big

problem, who will know where it is and what maintenance is required, and when it should be carried out.

Of course it is preferable if all junction boxes are accessible; however this amendment does

provide a solution to those difficult and unavoidable situations where a junction box is inaccessible and will avoid disputes.

So what are the requirements of BS 5733 for maintenance free accessory?

BS 5733

BS 5733 is the standard for accessories it has the title: General requirements for electrical accessories –Specification

Changes made to the 2010 edition of the standard include requirements for maintenance-free accessories.

A maintenance free accessory is defined in the standard as

An accessory which does not require further inspection, testing or maintenance after installation in a circuit, and which incorporates screwless terminals and cable clamps to secure any associated cables

It is to be noted that as well as requiring screwless terminals for maintenance free accessories the standard also requires cable clamps to secure the cables in the accessory, see the figure.

Maintenance free junction box

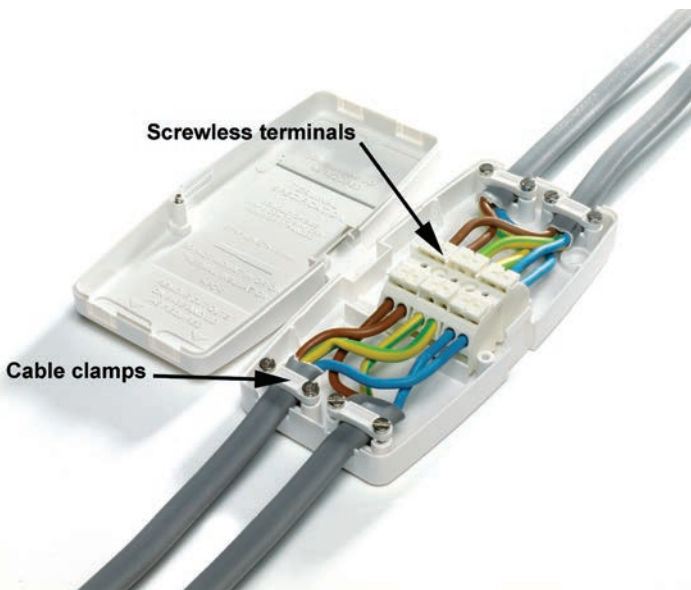

The standard has particular test requirements for the terminals in order to determine whether they are maintenance free. The standard requires:

- 14.5.2 Terminals shall have long-term connection capability.
- 14.5.3 Terminals shall be resistant to the effects of vibration.
- 14.5.4 Terminals shall withstand the effects of overloads and shall not cause ignition or damage to the mounting surface.
- 14.5.5 Terminals shall be sufficiently resilient to the effects of thermal shock.

There are tests and inspections specified that the test samples must pass. ►

WE DROVE 3000 MILES ACROSS AMERICA

TESTING BROTHER LABELS ON...



...AND EVEN ROUTE 66.

WHAT WILL YOU LABEL?

If you label yourself a true professional, the PT-7600VP electrician's label printer will provide you with unexpected versatility. Label everything from cables and fuse boxes, to organising all the tools and electrical components in your van.

VISIT BROTHER.CO.UK/ELECTRICIAN TODAY
OR CONTACT YOUR LOCAL ELECTRICAL WHOLESALER



/brotherlabels



/brotherprintersuk

What to look for

BS7671 also required junction boxes to meet the requirements of BS EN 60670-22: **Particular requirements for connecting boxes and enclosures.**

When buying junction boxes you will need to look for marking to indicate compliance with both BSEN 60670-22 and BS 5733, plus the CE mark -- a statement by the manufacturer that the accessory meets all relevant European directives



and of course not forgetting the mark to indicate the accessory is **Maintenance Free**:

The buyer will also need to confirm from the manufacturer's catalogue that the box is suitable for the cables to be connected e.g.

- a) rigid (solid or stranded) copper conductors only;
- b) flexible copper conductors only; or
- c) both rigid (solid or stranded) and flexible copper conductors

Good practice

When carrying out an electrical installation, accessories including junction boxes should not be installed in inaccessible positions, and for new installations this can be a firm objective. However when carrying out additions and alterations as well as rewires maintenance free junction boxes

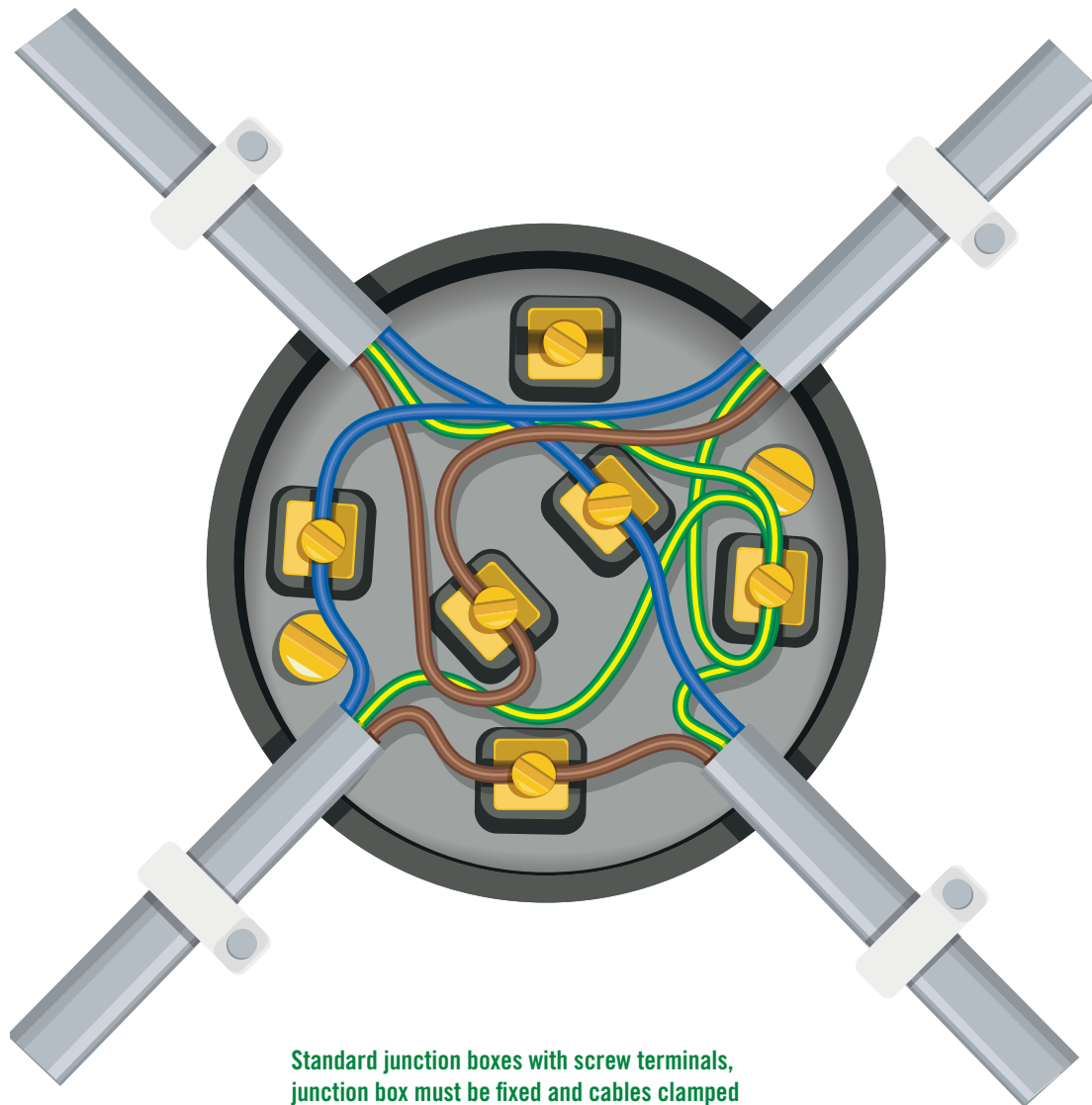

Standard junction boxes with screw terminals, junction box must be fixed and cables clamped

are going to be of great use.

Junction boxes with screw terminals are still going to be used. They can be used where they are accessible for maintenance inspection and repair. As standard junction

boxes have no cable clamps this means the box must be screwed down and the cables fixed to prevent strain on the connections.

Care must be taken with the connectors particularly with

stranded cables to ensure all the strands are clamped in the connector. If it is not going to be possible to clamp the cables then to comply with regulation 522.8.5 junction boxes incorporating a cable clamp must be used.

Junction box with screw terminals and cable clamp

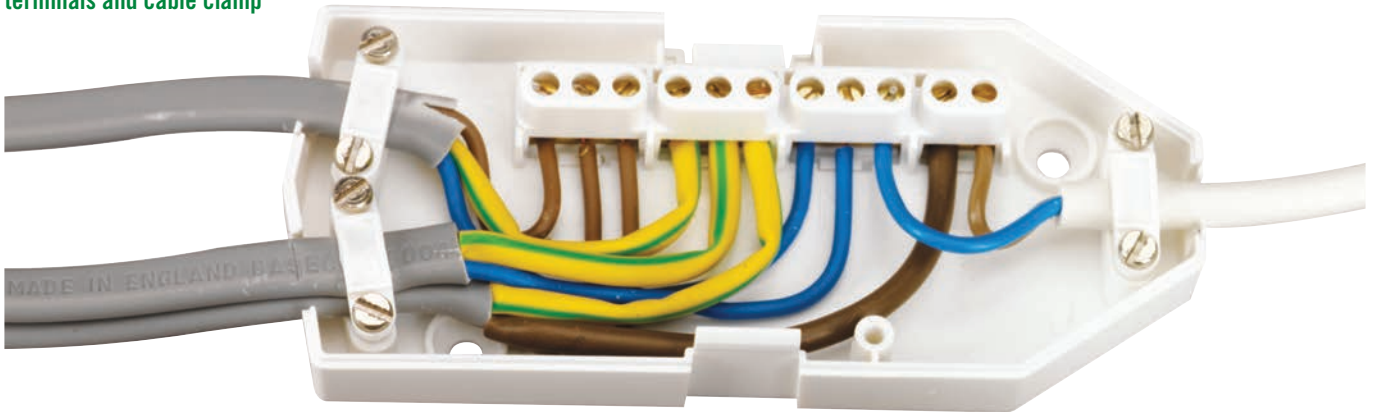

522.8.5 Every cable or conductor shall be supported in such a way that it is not exposed to undue mechanical strain and so that there is no appreciable mechanical strain on the terminations of the conductors, account being taken of mechanical strain imposed by the weight of the cable or conductor itself.

There are a range of such connecting boxes, some particularly designed for connecting luminaires. ■

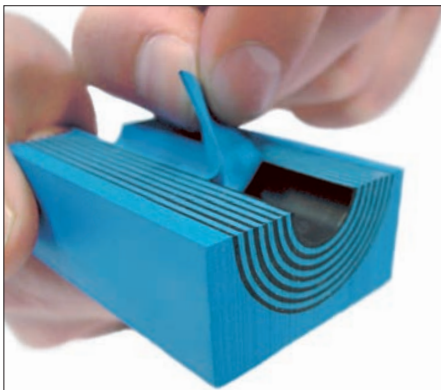

World Leader in Cable and Pipe Seals



EFFICIENT SEALING SOLUTIONS

- Quick and easy to install
- Global certifications and ratings
- Adaptable to cables of different sizes
- Always available from local stocks
- Capacity for future expansion

The Roxtec sealing system protects against flood, gas, fire, smoke, blast, dust and vermin. It also provides solutions for hazardous locations (Ex) as well as for EMC, bonding and grounding. Designed to ensure engineering performance, jobsite flexibility and operational reliability, it is frequently specified in major projects in different demanding industries. No wonder we are the global leader within modular-based cable and pipe seals.



Roxtec LTD
Unit C 1, Waterfold Business Park, Bury, BL9 7BQ Lancashire, United Kingdom
TEL +44 161 7615280, FAX +44 161 7636065
info@uk.roxtec.com, www.roxtec.com



Portable Appliance Testing – challenging the myths

In-service Inspection and Testing of Electrical Equipment

by the Health and Safety executive



Readers of this article will be familiar with the concept of in-service inspection and testing of electrical equipment, commonly but misleadingly referred to as portable appliance testing (PAT). Although IET and Health and Safety Executive (HSE) guidelines are available, the subject of PAT still causes confusion and concern for business. People are not clear about which equipment needs to be tested and uncertain about how often it should be done. We want to ensure that you, as electrical contractors or electricians understand what is required so your clients and customers can get the best advice.

The myth that all electrical equipment needs to be tested

every year by a qualified electrician was one that HSE refuted in its 'myth of the month' series back in 2007. More recently the issue of PAT has been raised in the course of Professor Löfstedt's independent review of health and safety legislation. He considered PAT an example of a regulation that is being applied too widely and disproportionately largely because there are many instances of equipment being inspected and tested too frequently and tested unnecessarily. He recommended that HSE further clarifies what is necessary and what is not.

As you know there is a legal requirement to maintain

electrical equipment if not maintaining it would result in danger. But there is no legal requirement to test equipment or that such testing should be carried out at any particular frequency. Despite this, some companies offering PAT services cite health and safety legislation as a reason for them. In fact checks and inspection of equipment by users may be the only action needed for portable appliances that are at low risk of developing hazardous faults.

HSE therefore welcomes this recommendation from Professor Löfstedt as it reflects our position in relation to maintaining electrical equipment, including portable appliances, that are at low risk

of developing hazardous faults and which are not subject to excessive wear and tear. It also supports HSE's view that the focus should be on an appropriate risk-based maintenance regime for electrical equipment (portable appliances and other forms of equipment).

HSE is clear that testing equipment including portable appliances can be a useful, and in some instances an essential, part of an effective maintenance regime but testing, if undertaken, is only one element of this. Visual checks by users and regular inspections of the equipment are also vital parts of any maintenance regime and, ►

9th International Railway Infrastructure Exhibition



The Definitive Rail Infrastructure Event



Supporting Organisations



Media Partners



1-3 May 2012

Hall 3, NEC | Birmingham, UK

Featuring: On Track Display, Seminar Theatre, Networking Area, Opening Ceremony, The Yard, Networking Reception, hundreds of exhibitors, thousands of products.

**Register now
for FREE at
infrarail.com**
(saving £15
on the door)

For more information: Tel: +44 (0)1727 814400 | Infrarail@mackbrooks.co.uk | www.infrarail.com



IET Standards Limited

- the first authoritative, practical installation guide for competent electrical installers
- developed and supported by all key players in the EV industry including government
- reflects latest advice on EV charging from HSE
- fully referenced to the latest European and international standards

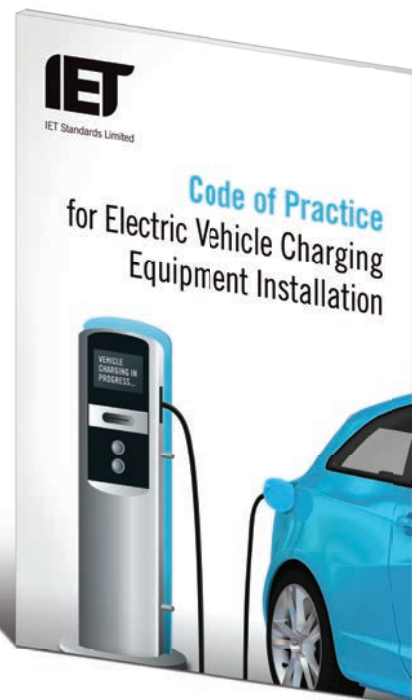

Out now

Find out more at www.ietstandards.com/EV6

IET Standards Limited is registered in England & Wales (no 7475762) and is a wholly owned subsidiary of the Institution of Engineering and Technology. The IET is registered as a Charity in England & Wales (no 211014) and Scotland (no SC038698). IET Standards Ltd, Michael Faraday House, Six Hills Way, Stevenage, SG1 2AY.



◀ particularly for appliances that are at low risk of developing hazardous faults, they may be the only action required.

When someone is thinking about testing portable appliances, in addition to visual inspection and the frequency at which this should be done, it is appropriate to

take a risk-based approach. The type of equipment, what it is being used for and the environment in which it is being used are all factors that will influence the need for and how often it should be tested. For example, for a business that uses equipment robustly in aggressive environments - such as a jobbing builder on

construction sites - frequent visual inspections and testing may be appropriate. Conversely, for businesses where portable equipment is rarely moved and sits in a benign environment such as computer equipment in an office then testing may only be required rarely, if at all.

And just to assure you, HSE is leading by example. Having reviewed the results of our annual tests of portable appliances in all our offices over the last five years, we have decided that further tests are not necessary for certain types of equipment for the foreseeable future, if at all. We will, of course, continue to monitor any faults reported as a result of user checks and visual inspections and review this decision if necessary.

Both inspection and testing, if required, should be undertaken by someone competent to do it. Businesses can easily arrange for a member of their staff to be trained to carry out formal visual inspections which are not technically demanding. This may be particularly

valuable for low risk businesses where inspection may identify most, if not all, problems with their equipment and thus avoid any unnecessary testing.

HSE is now taking forward Professor Löfstedt's recommendations and so will review and refresh its guidance on PAT in the next few months. We will work with key stakeholders, such as ESC, IET, NICEIC, SELECT, ECA, NAPIT, APAT and representatives of small businesses and user groups such as facilities managers to make sure that clear messages about PAT reach all those with an interest.

We need your help too, to challenge the myths. You are ideally placed to help businesses by providing proportionate advice and only promoting portable appliance testing when assurance about safety of electrical equipment cannot be obtained in any other way. If you have any comments and ideas on how we might tackle this together then please get in touch with us to discuss them further. ■



Section 702 Swimming pools and other basins

The 17th Edition of the Wiring Regulations (BS 7671:2008) introduced a number of notable changes to Section 702 (Swimming pools and other basins) when it was published in 2008.

By Geoff Cronshaw

The three most significant changes introduced by the 17th edition were:

Firstly the scope in the 17th edition was extended to include the basins of fountains.

Secondly zones A, B and C in the 16th Edition were replaced by zones 0, 1 and 2 (although the dimensions of the zones remained the same), except that there is no zone 2 for fountains.

Thirdly a solution was included for the installation of 230 volt luminaires for swimming pools where there was no zone 2 (previously zone C).

In comparison Amendment number 1 includes only a few minor changes. In this article will look at the main requirements for swimming pools only. The basins of fountains are not considered in this article.

THE RISKS

The risk of electric shock is increased in swimming pools and their surrounding zones by the reduction in body resistance and by good contact with Earth arising from wet partially clothed bodies.

Because of this risk, additional requirements for safety beyond the general requirements in parts 1 to 6 of BS 7671 apply to basins of swimming pools and paddling pools and their surrounding zones. The additional requirements are detailed in Section 702 of BS 7671.

ZONES

The requirements for the classification of external influences are based on the dimensions of three zones (examples are given in Figures

702.1 to 702.4 of BS 7671:2008). For a swimming pool, zones 1 and 2 may be limited by fixed partitions having a minimum height of 2.5 m (see Figure 1).

PROTECTION FOR SAFETY

Not surprisingly, the protective measures of obstacles and placing out of reach (Section 417) are not permitted. Also, the protective measures of non-conducting location (Regulation 418.1) and earth-free local equipotential bonding (Regulation 418.2) are not permitted.

Supplementary equipotential bonding is required between all extraneous-conductive-parts and the protective conductors of all exposed-conductive-parts in zones 0, 1 and 2, irrespective of whether they are simultaneously accessible, in accordance with Regulation 415.2. In zones 0, 1 and 2, any metallic sheath or metallic covering of a wiring system (e.g. conduit), either surface-run or embedded in walls, floors etc. at a depth not exceeding 50 mm, must be connected to the supplementary equipotential bonding.

There is no particular requirement to install a metal grid in solid floors. However, where there is a metal grid, it must be connected to the local supplementary bonding. It is important to note that Section 753 'Floor and ceiling heating systems' has requirements (such as a metal grid) where electric floor warming is installed.

The requirements for electric floor warming in swimming pool locations would be similar to the requirements for locations containing a bath or shower. ►

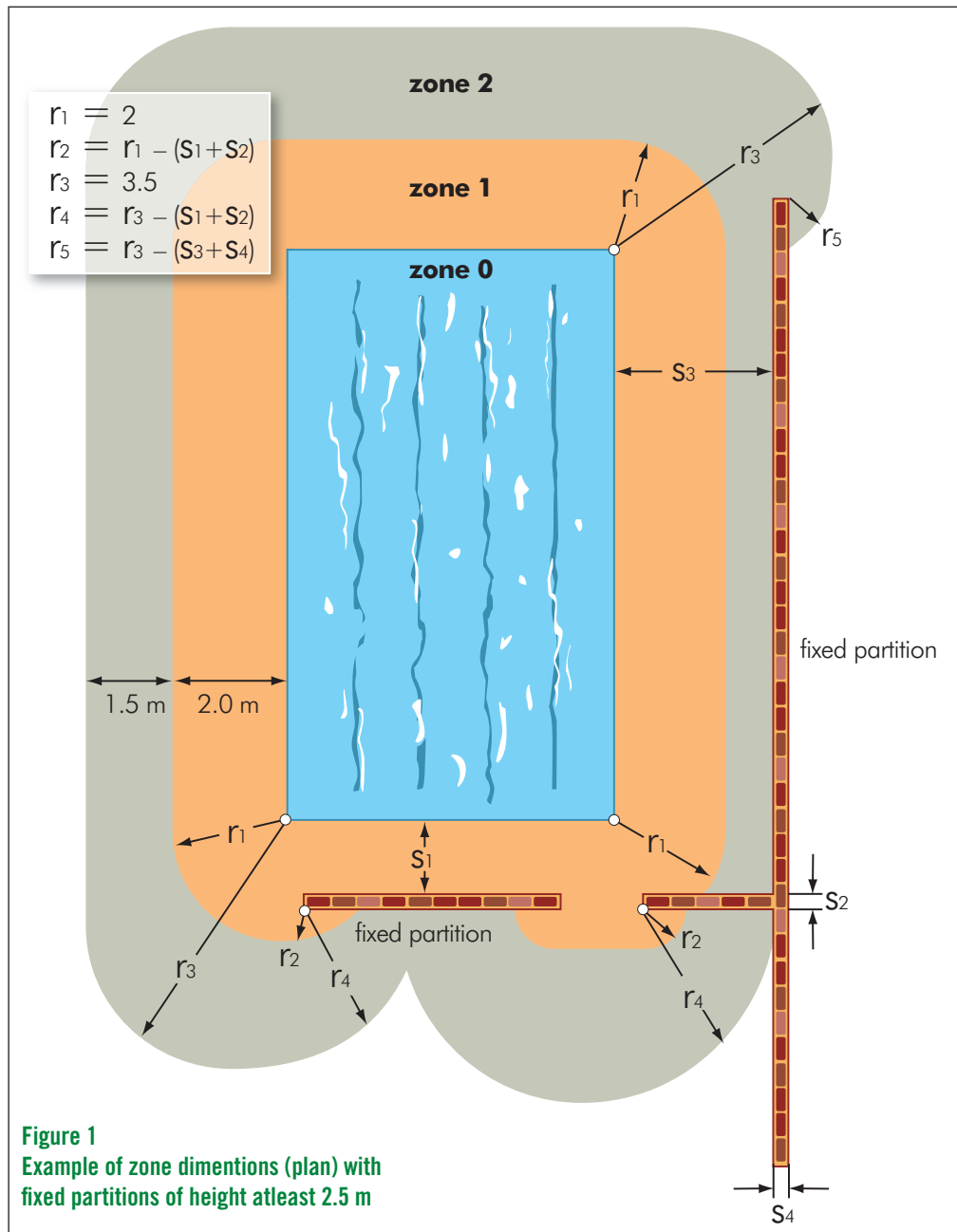

Figure 1
Example of zone dimensions (plan) with fixed partitions of height at least 2.5 m

PROTECTIVE MULTIPLE EARTHING

The Electricity Safety, Quality and Continuity Regulations 2002 (as amended) permit the distributor to combine neutral and protective functions in a single conductor provided that, in addition to the neutral to Earth connection at the supply transformer, there are one or more other connections with Earth. The supply neutral may then be used to connect circuit protective conductors of the customer's installation with

Earth if the customer's installation meets the requirements of BS 7671.

This protective multiple earthing (PME) has been almost universally adopted by distributors in the UK as an effective and reliable method of providing their customers with an earth connection. Such a supply system is described in BS 7671 as TN-C-S.

Whilst a protective multiple earthing terminal provides an

effective and reliable facility for the majority of installations, under certain supply system fault conditions (external to the installation) a potential can develop between the conductive parts connected to the PME earth terminal and the general mass of Earth. The potential difference between true Earth and the PME earth terminal is of importance when:

i. body contact resistance is low (little clothing, damp/ wet conditions), and/or

ii. there is relatively good contact with true Earth.

Therefore, a distributor may decide not to provide a PME earthing terminal for an installation such as that of a swimming pool. Where, however, a PME earthing terminal is provided, BS 7671 does not preclude its use for an installation that includes a swimming pool but recommends that an earth mat or earth electrode of suitably low resistance e.g. 20 ohms or less, be installed and connected to the equipotential bonding.

EXTERNAL INFLUENCES

Electrical equipment must have at least the following degree of protection according to BSEN60529:

(i) Zone 0: IPX8

(ii) Zone 1: IPX4, IPX5 where water jets are likely to be used for cleaning purposes

(iii) Zone 2: IPX2 for indoor locations, IPX4 for outdoor locations, IPX5 where water jets are likely to occur for cleaning purposes.

ZONES 0 AND 1

Switchgear, controlgear, accessories and junction boxes are not to be installed (except for SELV junction boxes in zone 1). Only current-using equipment specifically designed for a swimming pool application may be installed. However, socket-outlets may be installed in zone 1 (where it is not possible for them to be located outside zone 1) providing they are more than 1.25 m horizontally from the border of zone 0, at least 0.3 m above the floor, protected by a 30 mA RCD or by electrical separation with the safety isolating transformer installed outside of the zones.

The only wiring permitted in zones 0 and 1 is that necessary to supply equipment in those zones. Cables should preferably be installed in conduits made of insulating material.

ZONE 2

Equipment, socket-outlets, switches, and accessories are permitted in zone 2 but must be protected by electrical separation or SELV or a 30 mA RCD. Cables should preferably be installed in conduits made of insulating material.

LUMINAIRES FOR SWIMMING POOLS

In zones 0 and 1, only protection by SELV is permitted.

In zone 0, only protection by SELV at a nominal voltage not exceeding 12 V a.c. rms or 30 V ripple-free d.c. is permitted, the source for SELV being installed outside zones 0, 1 and 2.

In zone 1, only protection by SELV at a nominal voltage not exceeding 25 V a.c. rms or 60 V ripple-free d.c. is permitted, the source for SELV being installed outside zones 0, 1 and 2.

Note: For equipment for use in the interior of basins which is only intended to be in operation when people are not inside zone 0. See Regulation 702.410.3.4.1.

In zone 2, luminaires are required to be protected either by SELV, a 30 mA RCD or electrical separation. Luminaires can be protected by 30 mA RCDs, but the high protective conductor currents often found in such equipment must be carefully considered. The luminaire manufacturer's advice should be sought with the objective of determining the standing protective conductor current and the maximum protective conductor

current during starting so that the luminaires do not cause unwanted tripping of the 30 mA RCD. If RCD protection is used, then the luminaires should be on more than one circuit with separate RCDs.

A solution is included for the installation of 230 volt luminaires for swimming pools where there is no zone 2.

Regulation 702.55.4 states that for swimming pools where there is no zone 2, lighting equipment supplied by other than a SELV source at 12 V a.c. rms or 30 V ripple-free d.c. may be installed in zone 1 on a wall or on a ceiling, provided that the following requirements are fulfilled:

i the circuit is protected by automatic disconnection of the supply and additional protection is provided by an RCD having the characteristics specified in Regulation 415.1.1, and

ii the height from the floor is at least 2 m above the lower limit of zone 1.

In addition, every luminaire shall have an enclosure providing Class II or equivalent insulation and providing protection against mechanical impact of medium severity.

Please note there are special requirements for underwater luminaires for swimming pools. Refer to BS 7671:2008 incorporating Amendment 1. ■

It is important to be aware that this article only gives an overview of electrical installations in swimming pools. For more information refer to Section 702 of BS 7671:2008 incorporating Amendment 1.



Partner sponsor:
NICEIC PHILIPS

Technical Conference and Exhibition

S O U T H

17 May 2012
Epsom Downs Racecourse

N O R T H

1 November 2012
Bolton Arena

Cost:
NICEIC Registered rate
£36 (ex VAT)
Non NICEIC Registered rate
£56 (ex VAT)
Special promotion
The first 100 NICEIC registered contractors to book pay just £20 (ex VAT) per ticket!
BOOK NOW
for earlybird discount!

Why attend?

- Develop technical knowledge from industry experts and celebrity speakers
- Gather new ideas to diversify and grow your business
- Learn the latest updates and amendments to BS7671
- Network with leading industry suppliers and manufacturers and take advantage of show discounts on products and services
- Prize draws and giveaways

Book now @ www.niceiclive.com
or call us on 020 7324 2771

17th Edition (BS 7671:2008) incorporating Amendment No 1

Installations designed from the 1st January 2012 are to comply with Amendment number 1.

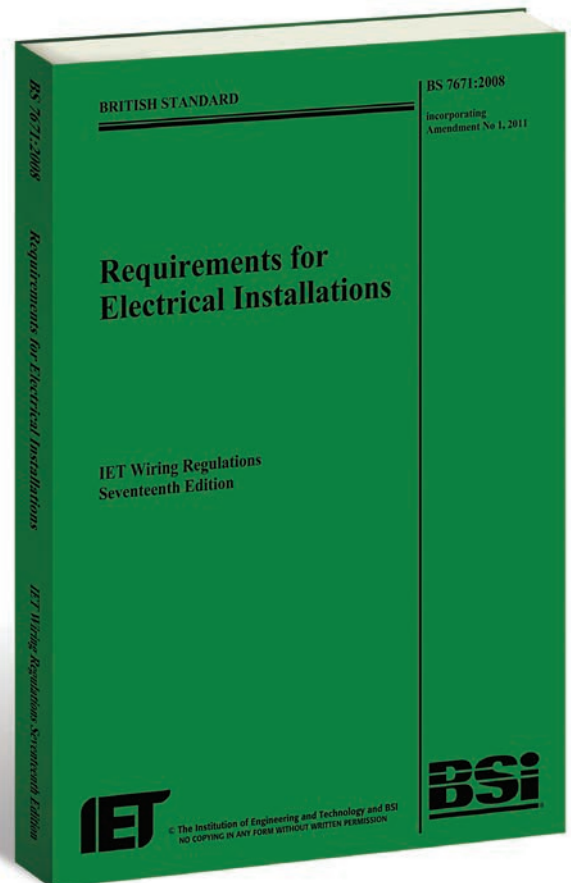

Geoff Cronshaw

The first amendment to the 17th edition came into effect on the 1st January 2012, and includes many new requirements that users of the wiring regulations need to be aware of. These range from medical locations, EMC, and surge protection, through to changes in the fuse standards and the associated maximum values of earth fault loop impedance for the new fuses.

Significant changes have been made for all those involved in periodic inspection and testing of electrical installations. The periodic inspection report in the 17th edition (BS 7671:2008) has been replaced with a new “Electrical Installation Condition Report” with inspection schedule and new observation codes in

Amendment No 1. In this article we look at the impact of some of the changes.

1. CHANGES TO THE PERIODIC INSPECTION REPORT

Appendix 6, Model forms for certification and reporting, now includes a new electrical installation condition report that replaces the periodic inspection report. In addition there is a condition report inspection schedule for domestic and similar premises up to 100 A supply.

For larger installations greater than a 100 A supply there is a list of examples of items requiring inspection instead of the inspection schedule. Finally, a schedule of test results is required to be completed for every distribution board and/or consumer unit for all

installations.

The periodic inspection report that was in the 17th edition has been modified to form the new electrical installation condition report in Amendment No 1. For example, within the observations section the four codes: 1 (requires urgent attention), 2 (requires improvement), 3 (requires further investigation), 4 (does not comply with BS 7671:2008 amended to ...) have been replaced by three codes: code 1 Danger present, code 2 potentially dangerous, code 3 improvement recommended.

The changes to the coding system and the condition report inspection schedule for domestic and similar premises up to 100 A supply represent a major change from the 17th

edition of the wiring regulations. For example, under this new coding system a summary of the condition of the installation in terms of safety should be clearly indicated in Section E of the condition report. Observations, if any, should be categorised in Section K of the condition report using the coding C1 to C3 as appropriate. Any observations given a C1 or C2 classification should result in the overall condition of the installation being reported as unsatisfactory, where as under the 17th edition only a number 1 (requires urgent attention), allocated to an observation would normally result in the overall assessment of unsatisfactory.

The new inspection schedules for domestic and similar

premises provide a detailed breakdown of the inspection required on each aspect of the installation to ensure that the work is carried out in an organised and efficient manner. For example, the schedule includes over 60 check points. Each item listed on the schedule which requires checking is accompanied with the relevant regulation number for ease of reference to the wiring regulations.

In addition, the form provides a facility to indicate the outcome of the inspection of each item with either a tick (acceptable condition), a code C1 or C2 (unacceptable condition), a C3 (improvement required), NV (not verified), Lim (limitation), or NA (not applicable); where as under the 17th edition the inspection of a general item would normally only result in a tick in a box.

2. SECTION 729 – OPERATING OR MAINTENANCE GANGWAYS.

Amendment 1 now includes Section 729, which applies to restricted areas. These are areas such as switchrooms with switchgear and controlgear assemblies with a need for operating or maintenance gangways for authorised persons.

This is a completely new section. The previous requirements for accessibility of electrical equipment in BS 7671:2008 were contained in Fundamental Principles in Chapter 13. These regulations remain the same. Regulation 132.12 states: Electrical equipment shall be arranged so as to afford as may be necessary: (i) sufficient space for the initial installation and later replacement of individual items of electrical equipment

(ii) accessibility for operation, inspection, testing, fault detection, maintenance and repair.

Regulation 15 of the Electricity at work Regulations has requirements for working space, access and lighting and requires that, for the purposes of enabling injury to be prevented, adequate working space, adequate means of access and adequate lighting shall be provided at all electrical equipment on which or near which work is being done in circumstances which may give rise to danger. Regulation 14 of the Electricity at work Regulations is concerned with work on or near any live conductors.

Accessibility

Regulation 729.513.2 requires that the width of gangways and access areas shall be adequate for work, operational access, emergency access, emergency evacuation and for the movement of equipment.

In restricted access areas where basic protection is provided by barriers or enclosures Regulation 729.513.2.1 gives the following minimum distances:

- i. Gangway width of 700 mm between: barriers or enclosures and switch handles or circuit-breakers in the most onerous position, and barriers or enclosures or switch handles or circuit-breakers in the most onerous position and the wall
- ii. Gangway width of 700 mm between barriers or enclosures or other barriers or enclosures and the wall
- iii. Height of gangway to barrier or enclosure above floor

(minimum dimension 2000 mm)

- iv. Live parts placed out of reach, see Regulation 417.3 (minimum dimension 2500 mm)

Note: Where additional workspace is needed eg for special switchgear and controlgear assemblies larger dimensions may be required.

In restricted access areas where the protective measure of obstacles applies Regulation 729.513.2.2 gives the following minimum distances:

- i. Gangway width of 700 mm between: obstacles and switch handles or circuit-breakers in the most onerous position, and obstacles or switch handles or circuit-breakers in the most onerous position and the wall.
- ii. Gangway width of 700 mm between obstacles or other obstacles and the wall
- iii. Height of gangway to obstacles, above floor (minimum dimension 2000 mm)

- iv. Live parts placed out of reach, see Regulation 417.3 (minimum dimension 2500 mm)

Note: the HSE would not expect to see any new switchboards installed in the UK where there was potential access to live exposed busbars.

Regulation 729.513.3 has requirements for access of gangways. For closed restricted access areas with a length exceeding 6 m, accessibility from both ends is recommended. However, gangways longer than 10 m must be accessible from both ends.

The Regulation recognises that this may be accomplished by placement of the equipment a minimum of 700 mm from all walls or by providing an access door, if needed, on the wall against which the equipment is positioned. However, closed restricted access areas with a length exceeding 20 m must be accessible by doors from both ends.

Finally, Annex A of Section 729 contains a number of ►

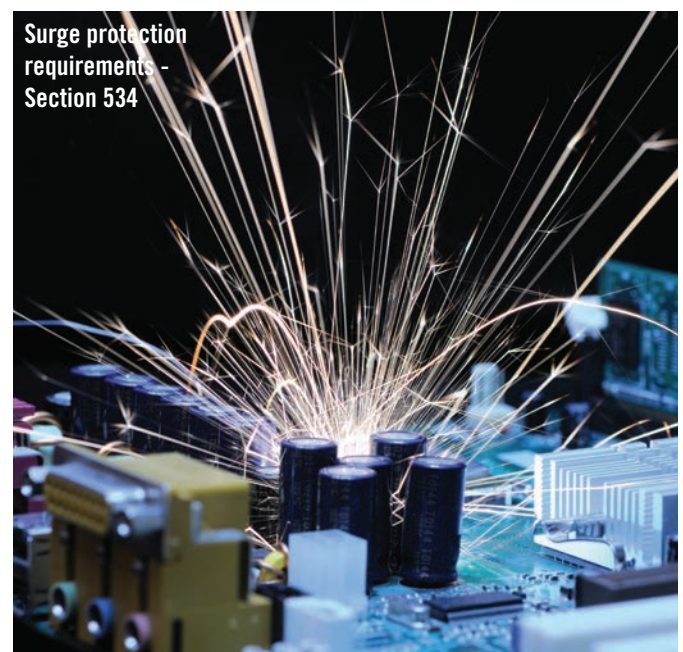

Surge protection requirements - Section 534

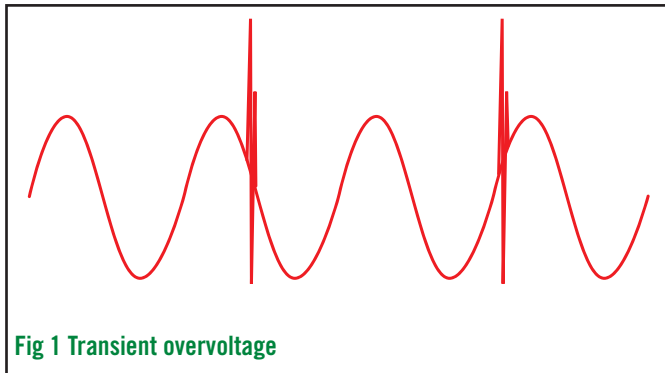

Fig 1 Transient overvoltage

additional requirements for closed restricted access areas in order to permit easy evacuation. The annex considers two cases; these include a minimum passing width of 700 mm with switchgear in position and 500 mm with circuit breakers completely extracted.

Persons involved in this work are advised to seek advice from the HSE.

3. NEW SECTION 534

The new Section 534 contains requirements for the installation of SPDs to limit transient overvoltages where required by Section 443 of BS 7671:2008 or where otherwise specified by the designer. See Fig 1.

An SPD is a device that is intended to limit transient overvoltages and divert damaging surge current away from sensitive equipment. SPDs must have the necessary capability to deal with the

current levels and durations involved in the surges to be expected at their point of installation. All SPDs are to comply with BS EN 61643.

As mentioned in a previous article, SPDs can operate in one of two ways, based on the component technologies within them. One way is as a voltage switching device where under normal conditions, the device is an open circuit. However at a certain threshold voltage the SPD conducts and diverts the current through it. It has two states ON and OFF, hence the name of voltage switching. Spark gaps, gas discharge tubes, thyristors (silicon controlled rectifiers), and triacs are examples of voltage switching devices.

Another way is as a voltage limiting device. Voltage limiting type SPDs again present an open circuit under normal circuit conditions. When an over voltage is detected the device begins to conduct,

dropping its resistance dramatically such that the overvoltage is limited and the surge current is diverted away from the protected equipment. Metal Oxide Varistors (MOVs) are a common example of voltage limiting devices. Advanced SPDs often utilise hybrid technologies combining voltage switching with voltage limiting components. See Fig 2.

Selection of SPDs

All SPDs are to comply with BS EN 61643. Typically, Type 1 SPDs are used at the origin of the installation, Type 2 SPDs are used at distribution boards and Type 3 SPDs are used near terminal equipment. Combined Type SPDs are classified with more than one Type, e.g. Type 1+2, Type 2+3.

Standards such as BS EN 61643 series (components for low-voltage surge protective devices) define the characteristics of lightning and voltages to enable reliable and repeatable testing of SPDs (as well as lightning protection components). Although these waveforms may differ from actual transients, the standardised forms are based upon years of observation and measurement (and in some cases simulation). They provide a fair approximation of the real-world transient.

The most important aspect in selecting an SPD is its voltage limiting performance during the expected surge event – this parameter is the SPD's protection level U_p , also known in industry as the SPD's let-through voltage. An SPD with a low limiting voltage or lower (hence better) protection level reduces the risk of flashover causing insulation breakdown and associated hazards (fire or electric shock)

as well ensure adequate protection of the equipment.

It should also be noted that selecting an SPD with a lower value U_p (compared to the equipment's damage threshold or withstand level U_w) results in a lower stress to the equipment which may result not just in a lower probability of damage, but also a longer operating life. As such, the risk assessment within BS EN 62305 defines SPDs with low voltage protection levels U_p as enhanced SPDs.

According to BS EN 62305, Type 1 enhanced SPDs should have a protection level U_p (or

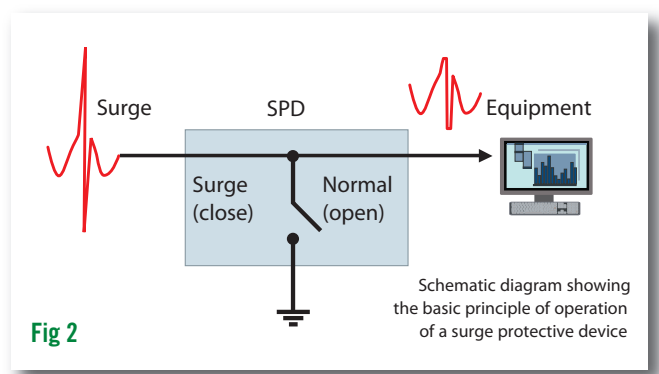
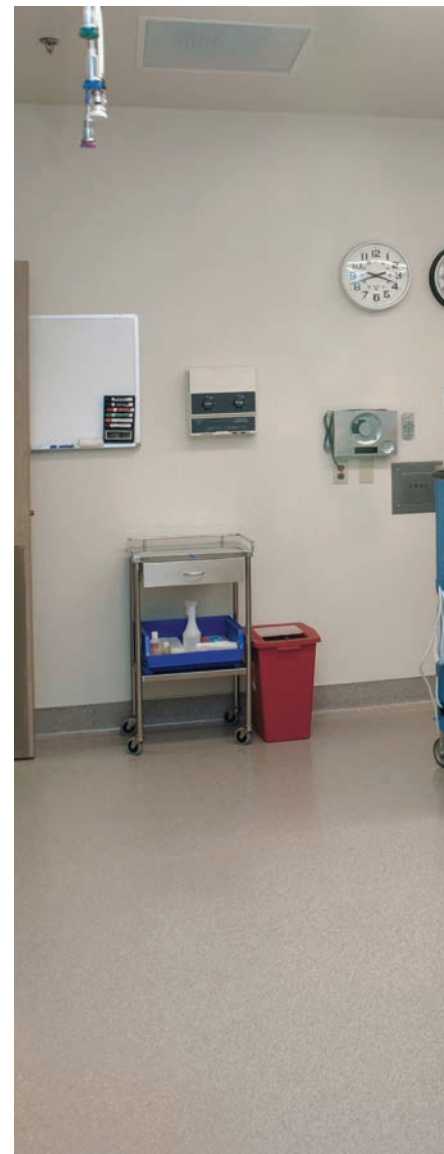

Fig 2

let-through voltage) no more than 1600 V whilst Type 2 and Type 3 SPDs should have a protection level U_p no more than 600 V when tested in accordance with BS EN 61643 series. Given that transients can be present between all conductors or modes (for example line to earth, line to neutral and neutral to earth) it is important to ensure good protection level U_p in all such modes.

Connection of SPDs

One important point to note is that in order to gain maximum protection the supply conductors of the SPD shall be kept as short as possible, to

minimise additive inductive voltage drops across the conductors.

Section 534 contains a number of requirements for the Connection of SPDs depending on the type of supply and system earthing. Therefore, for example, Section 534 requires that SPDs at or near the origin of the installation (if there is a direct connection between the neutral conductor and the protective conductor at or near the origin) shall be connected between each line conductor and the protective conductor/main earthing terminal whichever is the shorter distance.

SPD installation in conjunction with RCDs

Clause 534.2.6 of Section 534 is concerned with SPDs and their installation with respect to RCDs. It is ideal to install SPDs on the supply side of the RCD as this prevents the RCD from tripping during a surge event. Where this is not possible and SPDs are installed on the load side of an RCD transients could therefore trip the RCD. In this situation, 534 recommends the use of RCDs which are resistant to surge currents of up to 3 kA.

SPD status indication

SPD status indication needs to be provided by a status

indicator local to the SPD itself and/or remote, that the SPD no longer provides (or provides limited) overvoltage protection.

4. SECTION 710 – MEDICAL LOCATIONS

The risks

There are particular risks associated with medical locations. Therefore stringent measures are necessary to ensure the safety of patients likely to be subjected to the application of medical electrical equipment.

Shock hazards, due to bodily contact with the 50 Hz mains supply, are well known and documented. Currents of the ►



Medical locations

order of 10 mA passing through the human body can result in muscular paralysis followed by respiratory paralysis depending on skin resistances, type of contact, environmental conditions and duration. Eventual ventricular fibrillation can occur at currents just exceeding 20 mA. These findings are listed in IEC/TR2 60479-1 'Effects of current on human beings and livestock – general aspects'.

The natural protection of the human body is considerably reduced when certain clinical procedures are being performed on it. Patients under treatment may have their skin resistance broken or their defensive capacity either reduced by medication or nullified while anaesthetised. These conditions increase the possible consequences of a shock under fault conditions.

In patient environments where intracardiac procedures (see note 1, below) are undertaken, the electrical safety requirements are even stricter, in order to protect the patient against 'microshock'. Patient leakage currents from applied parts introduced directly to the heart can interfere with cardiac function at current levels which would be considered safe under other circumstances.

Patient leakage current which can flow into an earthed patient is normally greatest when the equipment earth is disconnected. A limit is set to the amount of leakage current which can flow in the patient circuit when the protective earth conductor is disconnected.

Patient leakage currents (see note 2) of the order of 10 μ A have a probability of 0.2 per cent for causing ventricular

fibrillation or pump failure when applied through a small area of the heart. At 50 μ A (microshock), the probability of ventricular fibrillation increases to the order of 1 per cent (refer to BS EN 60601-1).

Note 1

"Intracardiac procedure": This is a procedure whereby an electrical conductor is placed within the heart of a patient or is likely to come into contact with the heart, such conductor being accessible outside the patient's body. In this context, an electrical conductor includes insulated wires, such as cardiac pacing electrodes or intracardiac ECG electrodes, or insulated tubes filled with conducting fluids (catheter).

Note 2

"Patient's leakage current": Current flowing from a medical electrical equipment applied part via the patient to earth.

Additional to the consideration of risk from electric shock, some electromedical equipment (life-support equipment, surgical equipment) perform such vital functions that loss of supply would pose an unacceptable risk to patients. Medical locations where such equipment is used require secure supplies. This has implications not only for the provision of safety (emergency) power supplies but also render some conventional protection measures unsuitable. Hence, for example, when protecting circuits supplying critical medical equipment, restrictions are stipulated on the use of RCDs.

Additional measures

Since the type and description of these hazards can vary according to the treatment being administered, the

manner in which a medical room is used necessitates some division into different areas for differing medical procedures. Section 710 segregates medical locations into different "Groups". These are:

Group 0

medical location where no applied parts are intended to be used and where discontinuity (failure) of the supply cannot cause danger to life.

Group 1

medical location where discontinuity of the electrical supply does not represent a threat to the safety of the patient and applied parts are intended to be used as follows:

– externally – invasively to any part of the body, except where 710.3.7 applies

Group 2

Medical location where applied parts are intended to be used in applications such as intracardiac procedures, vital treatments and surgical operations where discontinuity (failure) of the supply can cause danger to life.

To protect patients from possible electrical hazards, Section 710 requires additional protective measures to be applied in medical locations.

These include: particular requirements for protection against electric shock; medical IT systems – requirements concerning supplementary equipotential bonding; additional requirements for the selection and erection of electrical equipment including switchgear and controlgear; safety services including the sources and detailed requirements for safety lighting. ■

Important: this article is only intended as a brief summary of some of the requirements in Amendment 1 of BS 7671:2008. Persons involved in these areas are recommended to consult Amendment 1 of BS 7671:2008 and seek specialist advice. Information on medical locations – IET Guidance Note 7 and UK Health Departments. Information on operating or maintenance gangways – HSE.



Professional Electrician

ELEX 2012

The Electricians' Exhibition

Sponsored by



Electrical excellence



- SEE AND TRY OUT ALL THE LATEST ELECTRICAL PRODUCTS FROM LEADING MANUFACTURERS AND SUPPLIERS
- HUNDREDS OF SHOW DISCOUNTS
- **FREE** INDUSTRY SEMINARS FROM THE ELECTRICAL SAFETY COUNCIL, NICEIC AND IET.
- **FREE PROFESSIONAL ELECTRICIAN T-SHIRT**
- **FREE** BACON ROLL

NEXT SHOWS:

**Westpoint Arena,
Exeter
26th & 27th April**

**Event City,
Manchester
21st & 22nd June**

**Ricoh Arena,
Coventry
20th & 21st Sept**

**Sandown Park,
Esher, Surrey
8th & 9th Nov**



To register for **FREE** entry, visit
www.elexshow.info



or call

01923 237799

Special locations: Filling stations

Further to the Earthing article in the Autumn issue of Wiring Matters, we thought we would develop a more detailed article on a 'special location', in this case Filling Stations.

**Gareth Bourhill IEng MIET MEI GCGI
and John Dallimore BTEch CEng FIET
FCIBSE MEI**

FILLING STATIONS frequently have almost unique electrical installation arrangements, not normally found elsewhere. At present there are just under 9,000 premises storing and dispensing fuel in the UK; however, the electrical installation at these sites is a specialist field, not normally encountered during the career of the average engineer and electrician.

During recent years there has been a marked swing of ownership and operation of these sites, from the major oil companies to the hypermarket operators. This has resulted in the development of some fairly large retail outlets on the filling station site and we have seen some serious implications with regard to electrical safety and the safe storage of fuel on these premises as work packages are frequently being split up and given to more than one electrical contractor.

Usually, a general electrical contractor is given the work in the retail outlet and other areas of the site and a filling station specialist contractor is given the installation serving the hazardous areas of the site.

We consider this to be poor planning and it could have implications for the end user with regard to the CDM Regulations. However, in this article, we wish to concentrate on electrical safety.

On new-build sites electrical packages are being given to a traditional shop-fitting or retail-outlet contractor, for design, installation and commissioning of the site switchgear and electrical circuits and equipment and accessories on and within the sales building



and peripheral areas of the site. A specialist electrical contractor, with experience in electrical systems and equipment for potentially explosive atmospheres is then employed to carry out the design, installation and commissioning of those circuits supplying the fuel system and associated specialist systems and equipment.

The end result of this is that the two installations are not properly coordinated; for

example, the design of the site main switchgear often falls short of the specialist requirements for filling stations and in particular the supplies to hazardous area equipment. The specialist contractor will often not commission his own work and this can lead to contractual disagreements between parties, delays to the project and an increase in cost for the client.

This could all so easily be avoided if contractors, clients, duty holders and project management companies remembered that everything within the legal boundary of the site is subject to the granting of a petroleum

licence by the local Petroleum Authority and is covered by numerous pieces of legislation, e.g.: Petroleum Consolidation Act 1928, DSEAR 2002, Health and Safety at Work Act 1974 and Electricity at Work Regulations 1989.

So what should the competent electrical ►



Figure 14.1
Simplified supply arrangements

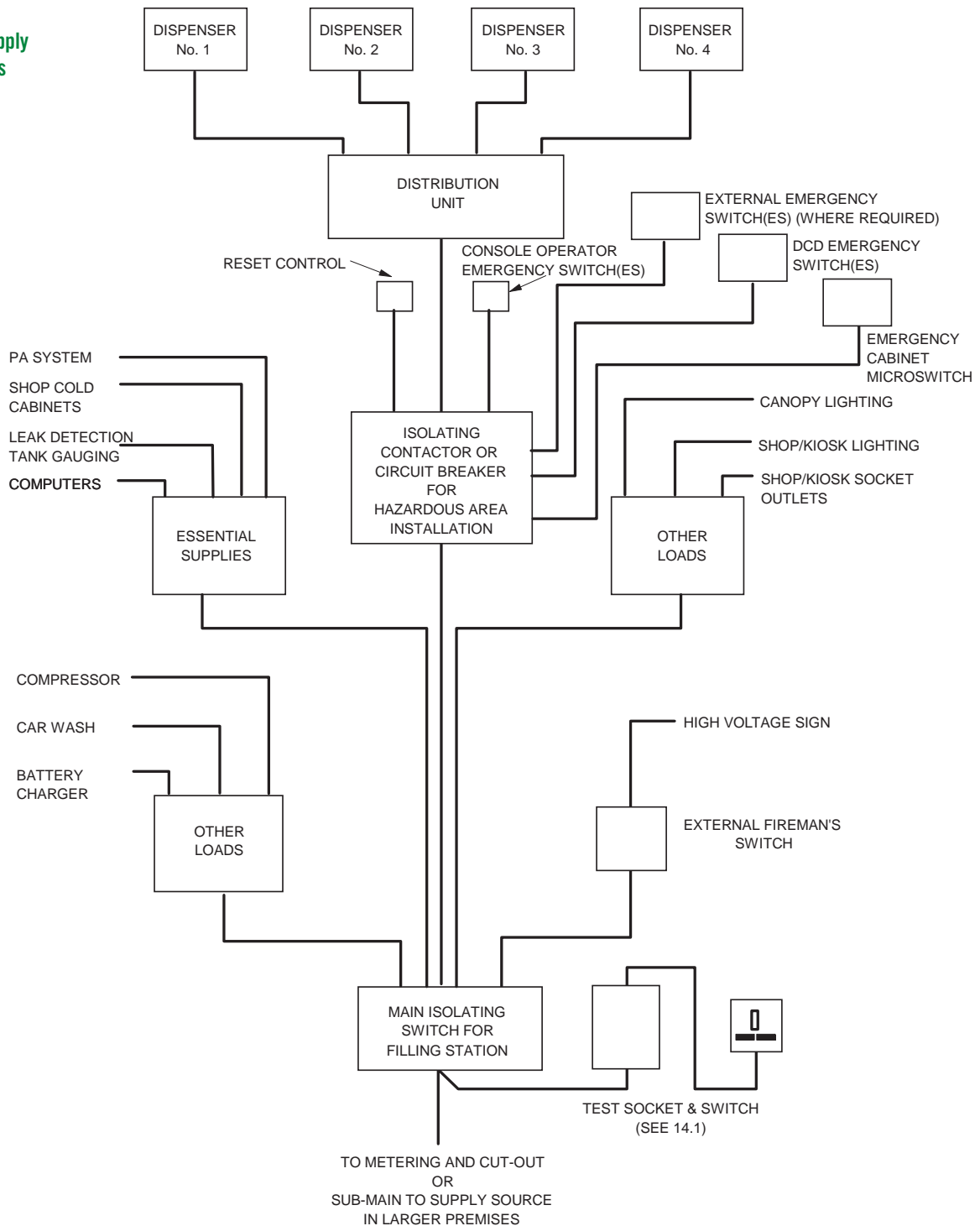

◀ contractor use as guidance and best practice?

BS7671:2008, Amendment No1 2011, will be useful in parts, but more so will be the BSEN 60079 series of standards for electrical installations in potentially explosive atmospheres.

However, unlike oil rigs, refineries and other process applications, where BSEN 60079 plays a principal role, at filling stations the 'risk' of hazards caused by the electrical installation and/or equipment is seen as greater for the simple reason that these premises have

uncontrolled and unlimited access to the public and are not under the supervision of a technical team or operator; often a site may have just one retail member of staff responsible for the entire operation. Over the last few years numerous unmanned sites have been constructed,

where there are no staff present during normal use.

A number of years ago when the HSE decided to withdraw its guidance document HS(G)41, it approached the Association for Petroleum and Explosive Administration (APEA) and the then Institute

of Petroleum (now the Energy Institute (EI)) to suggest that they should jointly publish a technical document to replace HS(G)41 and provide the retail petroleum industry with more comprehensive technical standards and guidance needed for modern filling stations.

This challenge was accepted by the APEA/EI and, since the late 1990s, both organisations have been involved in producing a best working practice guidance document 'Design, Construction, Modification, Maintenance and Decommissioning of Filling Stations', the first edition of which was published in 1999. The document is now not only seen as best practice here in the UK but is sold and used in many countries.

The most recent 3rd Edition of the 'Design, Construction, Modification, Maintenance and Decommissioning of Filling Stations' was published in June 2011 by the APEA/EI. Given the length of the title it is more commonly known in the filling station industry as "the Blue Book".

The document provides guidance on both new and existing sites and in particular, Chapter 14 includes comprehensive guidance on the electrical installation; from initial concept and planning with the client and end user, through design matters, installation detail, commissioning and test and inspection regimes and the maintenance regime.

The Blue Book does not extract detail from other standard electrical documents, it provides specific guidance on installations at filling stations, which generally

require higher technical requirements to ensure electrical safety and the safe storage and dispensing of petrol.

One of the classic mistakes made when a general electrical contractor designs the switchgear arrangement for the site is that he bases the requirements simply on the latest BS7671 requirements, without knowledge or thought for requirements for potentially explosive atmospheres. The Blue Book indicates that a TT earthing system or a guaranteed TN-S system from a dedicated on site transformer is preferred for the filling station supply. It also warns that a TN-S earthing system from the public supply should not be used, since there is no guarantee that there is a dedicated Earth conductor from the site back to the supply transformer. Clause 14.3.5 of the Blue Book refers.

The use of TN-C-S (more commonly known as PME) systems have been prohibited on UK filling stations since the introduction of the now obsolete HS(G)41 back in 1989. The reason is the risk of a spark occurring in hazardous areas as a result of Diverted Neutral Currents (neutral current flowing back to the supply transformer via the site earthing system and any metalwork bonded to the earthing system). Unfortunately, today we still see contractors using TN-C-S systems or worse, installing a TN-C-S system for the shop building and installing a TT system for the hazardous area circuits.

The Blue Book includes two useful diagrams (see below): a suggested arrangement for the switchgear for the site (Fig 14.3) and details of the preferred supply arrangement, showing the test socket and the TT earthing system (Fig

14.1) Such an arrangement will not normally be seen by non-filling station contractors.

The publication also gives detailed advice on cable types and termination arrangements (Clause 14.9). Inspection and Testing is covered in Clause 14.10 and there are a number of requirements not generally found in other installations; for example, Clause 14.10.2.1 states that the minimum insulation resistance for cables passing through or to the hazardous areas should not be less than 10 MΩ. The same clause states that where a TT earthing system is installed the aggregate earth electrode resistance must not exceed 20 Ω and the product of this resistance, multiplied by the rated residual tripping current in Amperes of the upstream RCD must not exceed 25.

The requirements for shock protection call for circuits on the filling station forecourt to ►

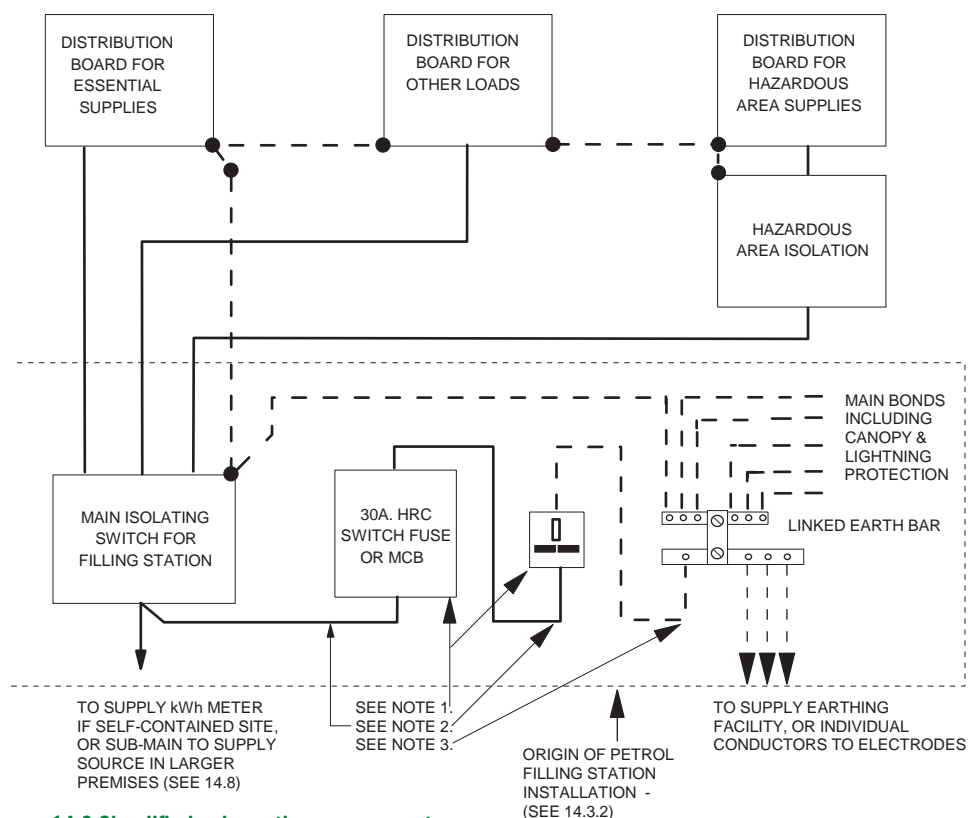

Figure 14.3 Simplified schematic arrangement

◀ have a maximum disconnection time of 100 mS, therefore, with a TT earthing system the correct supply and design of the RCD time/current cascading is very important. Typical examples would be a main protective device having a tripping current of 1 A and a time delay of 1 second, the sub-main devices perhaps being 300 mA tripping current and a time delay of 100 or 300 mS and final circuit devices 30 mA tripping current and instantaneous operation.

Another issue frequently overlooked is the requirement for RCD to break all live conductors; if this is not done the upstream devices may not be isolated from the fault and nuisance tripping may occur. This requirement is reinforced by the need to be able to isolate all live conductors on any circuits feeding into

hazardous areas. With anything up to two hundred final circuits, it is easy to understand how things can go wrong at the planning stage if a inexperienced contractor prices and installs switchgear without these items.

The electrical contractor also needs to know about the different dispenser and hydraulic systems on site and requirements for these, including the tank details, types of pipework and drainage systems, including the oil/water separator.

In recent years, with the availability of plastic type materials, filling stations now have conductive pipework, non-conductive pipework and semi-conductive pipework, all of which require their own special earthing and bonding arrangements to minimise a

build-up of electrostatic charge, especially during the delivery of fuel, which could create a spark in a hazardous area. Again, a general electrical contractor may not know of the precautions to be taken in this respect.

Filling stations are 'special locations' and require trained and 'competent' persons to design, install and maintain the electrical installation and equipment. It is often thought that the filling station shop is exactly that; however, it is not that simple; this 'shop' houses all the switchgear and the main earthing terminal for the licensed premises arrangements and apart from the statutory legislation of the Petroleum Licence, the appropriate parts of DSEAR 2002 and EAWR1989 state that equipment and systems located in a non-hazardous

area must not have a detrimental effect on equipment in a area where a potentially explosive atmosphere exists. Contractors and persons wishing to do work on filling stations should be aware of and practise the guidance given in the Blue Book, which is readily available from the APEA (www.apea.org.uk) or the EI (www.energyinst.org), in hardback or electronic form.

Gareth Bourhill is Co-Chair of the full APEA/EI Technical Review committee for the Blue Book and works as a freelance electrical safety consultant, trainer assessor. ■

John Dallimore is Chair of WG6 Electrical Sub Committee for the Blue Book and proprietor of his own specialist consultancy practice John Dallimore and Partners.



Electrical Training



- 17th Edition Wiring Regulations includes the First Amendment
- Inspection & Testing of Electrical Installations
- Broaden your skills - become HV Operational with C&G accreditation
- SMART Metering - the big roll out has started
- EU Skills Safety Passport - essential for electrical staff on construction sites

For more information, please go to
www.spenergynetworks.com/spcoursebookings
 Centres in Liverpool and Glasgow

Contact no: 01698 396465



EXTENDED PAT RANGE

Seaward PATs provide ready-made solutions for all workplace electrical appliance safety testing.

The hand held PrimeTest range includes lightweight and battery powered testers for the effective safety testing of all Class I and Class II electrical equipment.

These are designed to meet all levels of electrical equipment safety testing needs – from in-house safety testing to specialist PAT contract services.

Seaward Group is based at Bracken Hill, South West Industrial Estate, Peterlee, County Durham, SR8 2SW
 Tel. (0191) 586 3511 Fax. (0191) 586 0227 E mail: sales@seaward.co.uk

www.seaward.co.uk

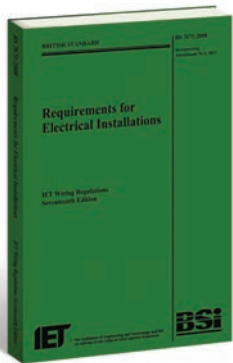

IET Wiring Regulations BS 7671:2008(2011)

Amendment No 1 is now in effect. Make sure you are working to the latest electrical installation requirements.

Get your copy today!

www.theiet.org/amend1
 T: +44 (0)1438 313311

www.theiet.org/amend1

Megger streamlines PAT testing for professionals



Fast to use, light to carry and featuring a huge internal database for results storage, Megger's PAT400 range are optimised to suit the needs of all regularly carry out PAT testers. Key benefits of the new instruments include rapid start up, instant restart when moving between test locations and optional barcode support. For more info go to <http://bit.ly/AOXFOX>

Megger Limited, Archcliffe Road, Dover CT17 9EN
 T: 01304 502 101
 F: 01304 502 307
 E: uksales@megger.com

www.megger.com/uk



Roxtec is the world-leader within cable and pipe penetration seals. The seals protect life and assets by providing an efficient barrier against water, fire, gas, blast, dust, rodents, and electromagnetic disturbance. The flexible sealing solutions simplify design, speed up installation and provide built-in spare capacity for upgrades and future expansion.

Roxtec Ltd.
 Unit C1, Waterfold Business Park
 Bury, Greater Manchester, BL9 7BQ
 Tel: +44 161 761 5280
 Fax: +44 161 763 6065
 Email: info@uk.roxtec.com

www.roxtec.com

Updated Guidance Notes now published



Guidance Note 5: Protection Against Electric Shock (6th Edition) and Guidance Note 7: Special Locations (4th Edition) are now available. Visit www.theiet.org/gns to buy yours today!

www.theiet.org/gns

Wiring Regulations Digital - £100 off the Industrial package

All 12 e-books in the industrial package + all the updated Amendment No 1 titles for just £250 (+VAT). Download onto your computer, laptop, iPhone or iPad. Call +44 (0) 1438 765 533 now and quote "WM offer" to buy yours.



Contact no: +44 (0) 1438 765 533

Why not promote your product or service in Wiring Matters magazine?

To find out more contact
Danielle Thomasson on
01438 767224 or
dthomasson@theiet.org

The Institution prepares regulations for the safety of electrical installations for buildings, the IET Wiring Regulations (BS 7671), which has now become the standard for the UK and many other countries. It has also prepared the Code of Practice for Installation of Electrical and Electronic Equipment In Ships (BS 8450) and recommends, internationally, the requirements for Mobile and Fixed Offshore Installations. The Institution provides guidance on the application of BS 7671 through publications focused on the various activities from design of the installation through to final test and certification with further guidance for maintenance. This includes a series of eight Guidance Notes, two Codes of Practice and model forms for use in wiring installations.

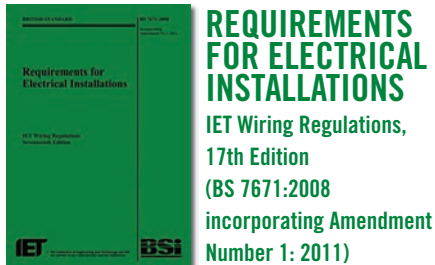

REQUIREMENTS FOR ELECTRICAL INSTALLATIONS

IET Wiring Regulations,
17th Edition
(BS 7671:2008
incorporating Amendment
Number 1: 2011)

The Wiring Regulations are the national standard to which all domestic and industrial wiring must conform. Substantial changes have been incorporated in BS 7671:2008 to align with European documents. Essential for all electricians, electrical contractors and their managers, installation designers, and students in further education and professional training.

- Paperback 429 pages
- Published 2011
- ISBN 978-1-84919-269-9
- Order book PWR1701B
- **£80**

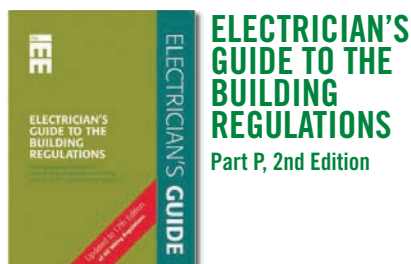

ELECTRICIAN'S GUIDE TO THE BUILDING REGULATIONS

Part P, 2nd Edition

Updated to align with the 17th Edition of the IEE Wiring Regulations, it also includes a new chapter on requirements for Scotland.

- Paperback 234 pages
- Published 2008
- ISBN 978-0-86341-862-4
- Order book PWGP170B
- **£22**

Want to order the 17th edition versions of any of our books?
Visit: www.theiet.org/wiringbooks



ON-SITE GUIDE

BS 7671:2008(2011)

The On-Site Guide is intended to enable the

competent electrician to deal with small installations (up to 100 A, 3-phase). It provides essential information in an easy-to-use form, avoiding the need for detailed calculations.

- Paperback 188 pages
- Published 2011
- ISBN 978-1-84919-287-3
- Order book PWG0171B
- **£24**

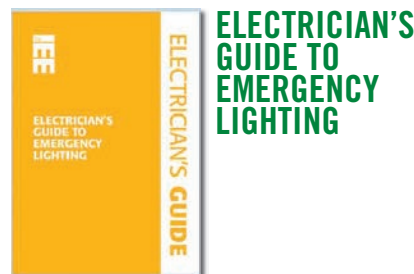

ELECTRICIAN'S GUIDE TO EMERGENCY LIGHTING

The Electrician's Guide to Emergency Lighting provides guidance on electrical installations in buildings.

This publication is concerned with emergency lighting and in particular emergency escape lighting and must be read in conjunction with the legislation: Approved Document B and the British Standards, in particular BS 5266.

- Paperback 88 pages
- Published 2009
- ISBN 978-0-86341-551-7
- Order book PWR05020
- **£22**

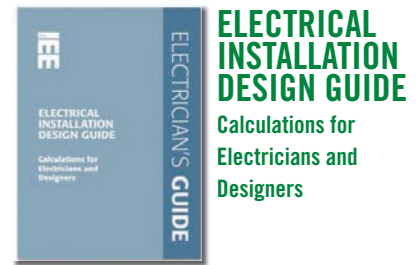

ELECTRICAL INSTALLATION DESIGN GUIDE

Calculations for
Electricians and
Designers

This book provides step-by-step guidance on the design of electrical installations, from domestic installation final circuit design to fault level calculations for LV/large LV systems. Apprentices and trainees will find it very helpful in carrying out the calculations necessary for a basic installation. It has also been prepared to provide a design sequence, calculations and data for a complete design to be carried out.

- Paperback 186 pages
- Published 2008
- ISBN 978-0-86341-550-0
- Order book PWR05030
- **£22**

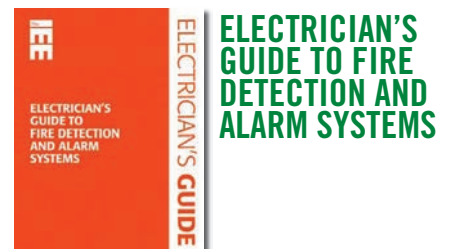

ELECTRICIAN'S GUIDE TO FIRE DETECTION AND ALARM SYSTEMS

This is one of a number of publications prepared by the IET to provide guidance on electrical installations in buildings. This publication is concerned with fire detection and fire alarm systems and must be read in conjunction with the legislation, Approved Document B and the British Standards, in particular BS 5839-1 and 5839-6.

- Paperback 100 pages
- Published 2010
- ISBN 978-1-84919-130-2
- Order book PWR05130
- **£22**

For full information and contents, please visit www.theiet.org/wiringbooks



Commentary on IEE Wiring Regulations 17th Edition BS 7671:2008 Requirements for Electrical Installations

P. Cook

This is a complete guide to the IEE Wiring Regulations. It provides comprehensive guidance on all aspects of electrical installation design. It is essential reading for consultants, designers, electricians and all those with a professional interest in the Wiring Regulations.

- Hardback 504 pages
- Published Aug 2010
- ISBN: 978-0-86341-966-9
- Order book PWR08640
- **£65**



GUIDANCE NOTE 3 Inspection & Testing, 6th Edition

Suitable for the City & Guilds 2391 Certificate in Inspection, Testing and

Certification, this Guidance Note is concerned principally with Inspection and Testing. It has been updated to align with the IEE Wiring Regulations 17th Edition (BS 7671:2008). It includes detailed coverage of initial verification, periodic inspection and test instruments.

- Paperback
- Publishing Apr 2012
- ISBN 978-1-84919-275-0
- Order book PWG3171B
- **£27 (Pre-order £22.95)**



GUIDANCE NOTE 6 Protection Against Overcurrent, 6th Edition

This Guidance Note enlarges upon and simplifies relevant requirements of

BS 7671:2008. It includes guidance on protection of conductors in parallel against overcurrent and includes an overview of the new appendix 4 of BS 7671:2008.

- Paperback
- Publishing May 2012
- ISBN 978-1-84919-281-1
- Order book PWG6171B
- **£27 (Pre-order £22.95)**

Pre-order the updated Guidance notes and get a 15% discount



GUIDANCE NOTE 1 Selection & Erection of Equipment, 6th Edition Order book PWG1170B

This Guidance Note enlarges upon and simplifies relevant requirements of BS 7671:2008. It includes detailed coverage of mechanical maintenance, emergency switching, functional switching in easy-to-read text. It also includes illustrations in full colour.

- Paperback
- Publishing Apr 2012
- ISBN 978-1-84919-271-2
- Order book PWG1171B
- **£32 (Pre-order £27.50)**



GUIDANCE NOTE 2 Isolation & Switching, 6th Edition

This Guidance Note enlarges upon and simplifies relevant requirements of BS 7671:2008. It includes detailed coverage of mechanical maintenance, emergency switching, functional switching in easy-to-read text. It also includes illustrations in full colour.

- Paperback
- Publishing May 2012
- ISBN 978-1-84919-273-6
- Order book PWG2171B
- **£27 (Pre-order £22.95)**



GUIDANCE NOTE 4 Protection Against Fire, 6th Edition

This Guidance Note enlarges upon and simplifies relevant requirements of BS 7671:2008. It includes detailed coverage of thermal effects, locations with increased risk, cable selection and safety service in easy-to-read text. It also includes full-colour illustrations.

- Paperback
- Publishing May 2012
- ISBN 978-1-84919-277-4
- Order book PWG4171B
- **£27 (Pre-order £22.95)**



GUIDANCE NOTE 5 Protection Against Electric Shock, 6th Edition

OUT NOW

This Guidance Note enlarges upon and simplifies relevant requirements of BS 7671:2008. It includes detailed coverage of the protective measures against electric shock. It also includes full-colour illustrations.

- Paperback
- Publishing Feb 2012
- ISBN 978-0-84919-279-8
- Order book PWG5171B
- **£27**



GUIDANCE NOTE 7 Special Locations, 4th Edition

OUT NOW

This Guidance Note includes detailed coverage of new special locations covered in the IEE Wiring Regulations 17th Edition in easy-to-read text. It also includes full colour illustrations.

- Paperback
- Publishing Feb 2012
- ISBN 978-0-84919-283-5
- Order book PWG7171B
- **£27**



GUIDANCE NOTE 8 Earthing and Bonding 2nd Edition

This Guidance Note is principally concerned with aspects of earthing and bonding

This title is in the process of being updated and the electronic update will be available to download soon.

- Paperback
- Publishing Mar 2012
- ISBN 978-0-84919-285-9
- Order book PWG8171B
- **£27 (Pre-order £22.95)**

For full information and contents, please visit www.theiet.org/wiringbooks

Don't miss your next copy of Wiring Matters

Have you re-subscribed yet?

Yes? Great, then you will continue to receive Wiring Matters as usual and have access to all the latest developments around BS 7671 from the IET – your industry experts. You do not need to do anything else.

No? Then you must re-subscribe now for FREE to ensure that you will continue to receive the magazine.

There are two easy ways to do this.

1. Simply fill in the printed registration card that came with this issue of the magazine and send it back to the details given at the bottom of the card.
2. You can re-subscribe online using your Unique Reference Number*.

This is your Unique Reference Number needed for the online form. Please note that you only need the numerical digits.



0095253362 WM 58111
MR A SAMPLE
ELECTRICAL CONTRACTOR
A COMPANY LTD
1 SAMPLE STREET
LONDON
AB1 2CD

Go to www.subscription.co.uk/cc/wm/ma12

Select the renewal box.

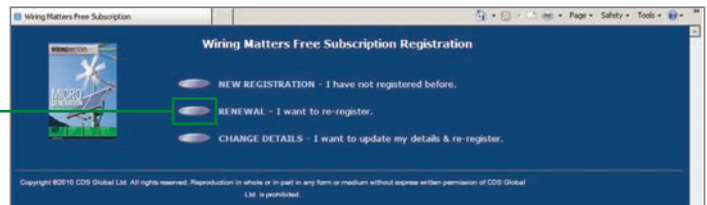

Wiring Matters Free Subscription Registration

NEW REGISTRATION - I have not registered before.

RENEWAL - I want to re-register.

CHANGE DETAILS - I want to update my details & re-register.

Enter your Unique Reference Number, select 'Continue' and follow the instructions on the next page.

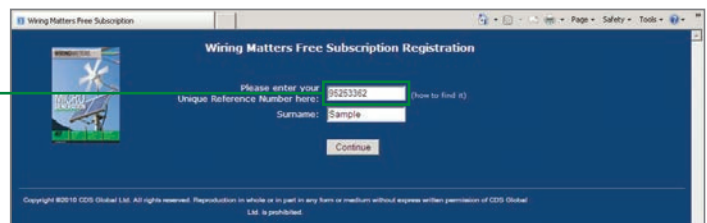

Wiring Matters Free Subscription Registration

Please enter your Unique Reference Number here: (How to find it)

Surname:

You will then just need to check your details are correct and update your information by completing a few tick boxes.** Once you have re-subscribed you will continue to receive the magazine as normal.

* If you have destroyed the magazine wrapper and need a copy of your unique reference number, please send an email to controlled1@subscription.co.uk with your full name and address details.

** If you are retired, for questions 1, 3 & 4, select "Other" and put "retired" in the box provided.

Membership includes...



1 DOMESTIC



2 COMMERCIAL



3 INDUSTRIAL

...work at no extra charge!

Benefit from all this with **NAPIT**

- ✓ NO EXTRA CHARGE for commercial and industrial membership
- ✓ NO EXTRA CHARGE for Electrical Installation Condition Reports (EICR)
- ✓ WORK QUALITY guarantee on notified work
- ✓ FREE membership to electrical Trade Association and online forum
- ✓ FREE legal and technical advice helplines
- ✓ SAVE up to £180 when joining from another scheme provider*

*Terms apply



0800 954 0438

info@napit.org.uk

www.napit.org.uk